

## Using RestoreX in 3 Simple Steps

Secure • Extend • Rotate

### ***PathRight Medical recommends the following:***

- Watch the quick start video prior to reading the remainder of this manual. The video provides a helpful overview of the use of RestoreX.
- Carefully review the treatment time chart on page 24. Following the chart will help you successfully use the RestoreX device.
- You may use the RestoreX device while sitting, standing or lying down. PathRight Medical recommends the sitting or lying down positions.
- During treatment you may wear a pair of athletic shorts or light pair of sweat pants.
- Use RestoreX every day as directed. Missing a few days may reduce results.
- The white bands should not be visible when RestoreX is treating in the angled position (pg. 22).
- In the straight position (pgs. 18-19), at a minimum make sure the white bands are not visible. If you can tolerate more tension, advance the extension rods another notch.
- In the angled position (pg. 22), do your best to get to the 3rd or 4th stop (90 or 120 degrees).

## Step 1 - Secure the Penis in the Clamp

### Opening the Clamp

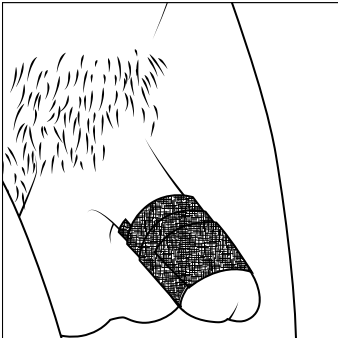

Figure A

To improve comfort, use the supplied self-adherent wrap (Figure A) by gently wrapping it two or three times around your flaccid penis. Overlap the wrap as you go around the penis. **Do not overtighten.** If worn too tightly, the wrap can restrict blood supply to the penis. In some cases, use of the wrap may require adjustment of the clamp height **Part 5** (pg. 13).

**Note:** Use wrap prior to expiration date.

**Note:** Some men find that the wrap may stick to the skin and can be uncomfortable to remove. Remove slowly! An under-layer of gauze, pre-wrap, or tissue (toilet paper) may reduce discomfort and avoid unwanted sticking to the skin.

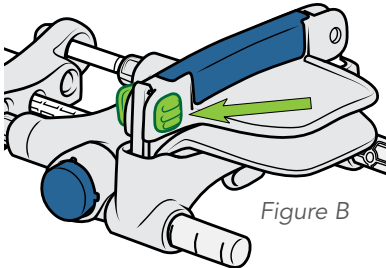

Figure B

**First**, open the clamp by pushing the clamp lock towards the pelvic ring (Figure B). This is the open position.

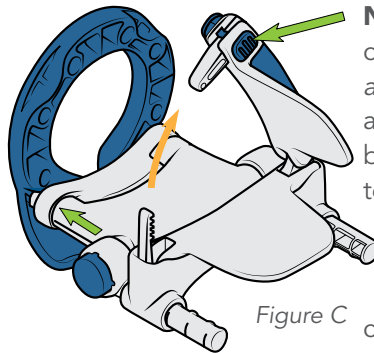

Figure C

**Next**, open the clamp (yellow arrow, Figure C) and push the main body of RestoreX toward the pelvic ring so RestoreX is locked in its shortest configuration. Now put RestoreX on.

## Step 1 - Secure the Penis in the Clamp (Cont.)

### Positioning the Device and Closing the Clamp

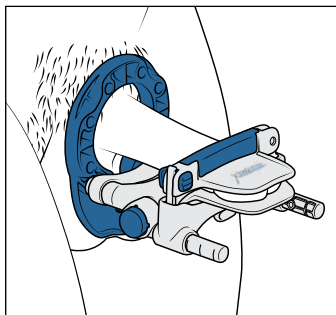

Figure D

To put RestoreX on, insert your penis through the pelvic ring. While holding the pelvic ring against your body, place the head of your penis into the open clamp. In this position slowly close and secure the clamp (Figure D) closing to the number of clicks achieved in **Part 5** (pg. 13) or until it is as tight as can be comfortably worn for 30 minutes. Push the clamp lock all the way closed (Figure E) to ensure the proper long-term functioning of the lock.

**Note:** If the clamp lock is in the open position you will not hear any clicks and will have to push the lock closed when you reach the desired location (Figure E).

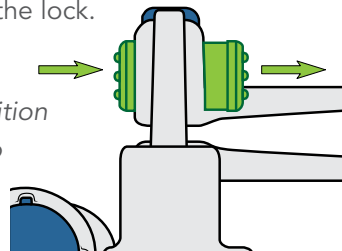

Figure E

**Note:** If during the clamping process or treatment session you experience pain or numbness in the penis, open the clamp, reposition the penis and continue the treatment. If pain persists, see Warnings and Precautions (pg.25), stop the treatment session and contact either your physician or RestoreX customer service at **1-877-228-5147**.

**Note:** If, during the treatment session the RestoreX device changes position, reduce tension, reposition and re-tension.

## Step 2 - Extend and Add Tension

With the penis secure in the clamp, you are ready to add traction.

First, locate the white bands on the tension rods. The goal in extending the RestoreX device and adding tension is to have the white bands “disappear” into RestoreX. When the white bands are no longer visible, you’ve achieved the minimum amount of tension.

Users of the RestoreX device use two different methods to extend the device and add tension. Practice with both to discover which is best for you.

The **first method** is to release the tension rods and then advance RestoreX along the extension rods until the white bands are no longer visible. (*Figures F & G*)

The **second method** is preferred by some users, particularly men that have difficulty with the head of their penis slipping out of the clamp. First, advance the RestoreX device on the extension rods (*Figure G*) until the penis is nearly fully stretched. Next, **carefully and slowly** release the lock on the tension rods (*Figure F*) allowing them to fully stretch the penis and achieve tension.

**More detailed instructions appear on page 20.**

## Step 2 - Extend and Add Tension (Cont.)

Figure F

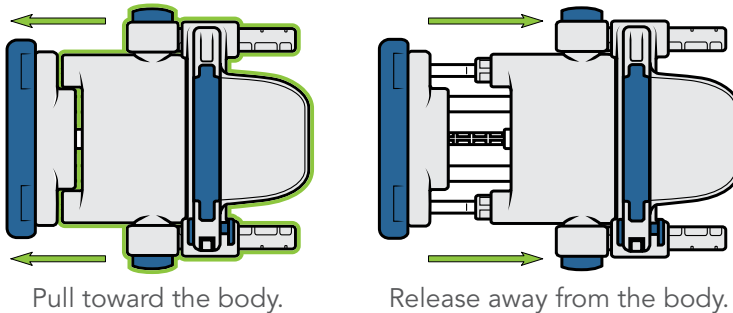
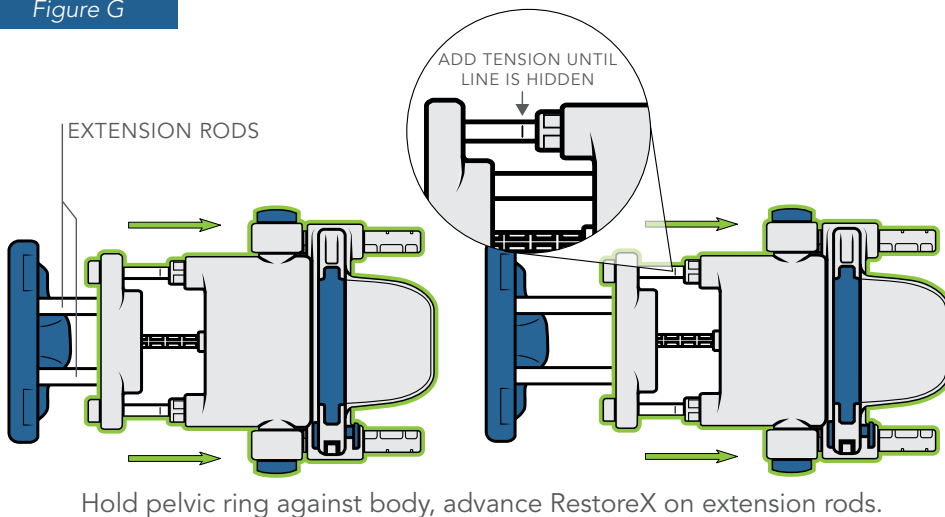

Figure G



## Step 2 - Extend and Add Tension (Cont.)

### Method 1

- Unlock the tension mechanism (springs) by pulling RestoreX back toward your body.
- Slowly and with control allow the springs to release and expand (the lock operates like a ball point pen) (*Figure F, pg. 19*).
- While holding the pelvic ring against your body, advance the RestoreX device on the extension rods, one notch at a time until the tissue pulls back enough that the white bands are no longer visible (*Figure G, pg. 19*).

### Method 2

- With the tension rods still locked, advance RestoreX on the extension rods until the penis is nearly fully stretched (*Figure G, pg. 19*).
- Slowly and very carefully, unlock the tension rods by first pulling back toward your body and then releasing, much like a ball point pen. Do not release abruptly! Release slowly and under control (*Figure F, pg. 19*).
- Next, if the white bands are still visible, relock the tension rods by pulling back toward your body until they relock. Now, while holding the pelvic ring against your body, advance RestoreX an additional notch on the extension rods. Again, release the tension rods by pulling back toward your body and then releasing slowly and under control. Repeat this process until the white bands are no longer visible.

## Step 2 - Extend and Add Tension (Cont.)

### **The following notes apply to both Methods 1 and 2**

**Note:** If at anytime you feel pain, excessive pressure, or pinching, reduce tension by pulling the main body of RestoreX back on the tension rods and lock into place. Reposition the base ring against the body and re-apply traction to assure the penis is firmly secured but still comfortable enough to be worn for 30 minutes.

**Note:** It is important during treatment that the penile skin is rather loose. If the penile skin is overly tight, it could result in discomfort and reduced results. To prevent this, gently encourage more of the penile skin and skin in the pubic area through the pelvic ring or slightly adjust the location of the pelvic ring from time to time to assure that the deeper penile tissues are being stretched.

## Step 3 - Rotate Opposite the Curvature

### Applying Tension in the Angled Position

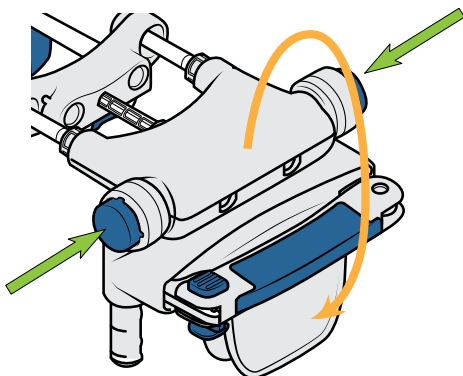

Figure H

RestoreX allows you to bend the penis in the opposite direction of the curvature. To do so, push the two buttons simultaneously and then rotate the clamp around to one of the four stops/positions (*Figure H*). You may only be able to initially achieve the first or second stop. However, after a few minutes, you may be able to advance to the next position. In order to achieve a maximal bend/angulation, you may need to reduce tension prior to rotating. To do so, slide the extension release (see pg. 8) on the bottom of the device and

move the main body back toward the pelvic ring until you are able to achieve the angled position. Once complete, you may re-apply tension by advancing on the extension rods until the white band on the tension rods is not visible.

**Note:** If the distance from the Penis Tip to the curvature of your penis is greater than 4 inches or 10.0 cm (see part 4, p. 11), only use the first or second stop (30° or 60°). Limiting the angle of the opposite force will increase the tension applied to the disease location.

**Note:** Many men have found that wrapping the penile shaft with tissue or gauze allows the penile skin to slide easily and more comfortably over RestoreX when using the 3rd or 4th position for rotation in the opposite direction of the curvature.



## Removing RestoreX

To remove RestoreX, slowly and gently release the clamp by pushing the clamp locking button toward you (*Figure I*), slowly and gently open the clamp and remove the device.

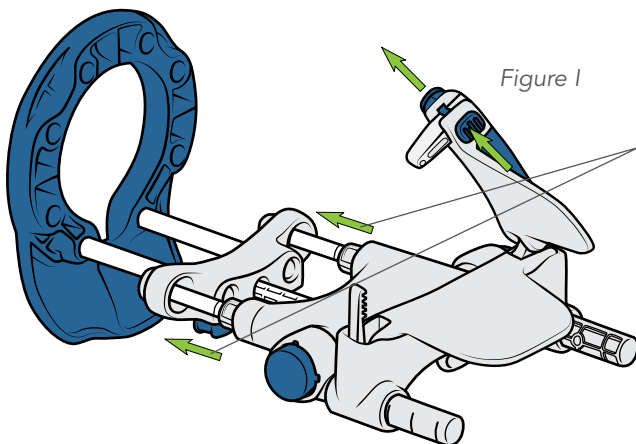

Figure I

If it is difficult to release the clamp, push both rotation buttons simultaneously to return the RestoreX device to the straight position as depicted (*Figure I*) **or** move the main body along the tension rods toward the pelvic ring and lock into place. Now, open the clamp and remove the device.

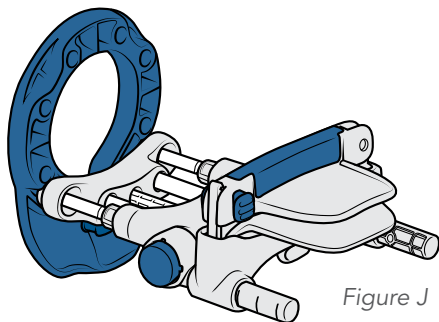

Figure J

Store the RestoreX device in the unlocked position (springs extended) until the next use (*Figure J*). If used, remove the self-adherent wrap.

## Recommended Treatment Times

Calendar	Time: Straight Position	Time: Angled Position	Treatments per Day	Total Therapy Time per Day
<b>Days 1 and 2</b>	8 minutes	2 minutes (Position 1 or 2)	3	3 treatments x 10 min = 30 mins
<b>Days 3-7</b>	13 minutes	2 minutes (Position 1 or 2)	3	3 treatments x 15 min = 45 mins
<b>Weeks 2-12</b> <i>or Per Your Doctor's Recommendation</i>	15 minutes	15 minutes (Position 3 or 4)	2	2 treatments x 30 min = 60 mins
Calendar	Time: Straight Position	Time: Angled Position	Treatments per Week	Total Therapy Time per Week
<b>Weeks 13-52</b>	15 minutes	15 minutes	1/Week	30 min

- After 12 weeks you may continue to use RestoreX 30 minutes twice daily until the penis is fully straight or you stop identifying improvements. Once you have achieved a satisfactory result, utilize RestoreX 15 minutes straight and 15 minutes angled once weekly to maintain the improvements achieved.
- For multiple curvatures, treat the largest and most bothersome curve first. Once adequately treated, adjust RestoreX to treat another location. Consult with your physician if you are unsure which curvature to treat first.
- Consult with your physician to determine the length of treatment.